

AMA 2008 e 2012

appendiabiti / coat-rack



MATERIALE
basamento in pietra lucidata
e scolpita a mano,
tondini in metallo verniciato
o rivestiti in corda

Peso: Kg 34,00

COLORI
LTG-119 base nera, tondino con corda nera

LTG-226 base nera, tondino nero
LTG-227 base bianca, tondino nero

MATERIAL
base in hand-sculpted
polished stone,
metal varnished rods
or coated rope

Weight: Kg 34,00

COLOURS
LTG-119 black base, black rods with rope

LTG-226 black base, black metal rod
LTG-227 white base, black metal rod
ONLY for CONTRACT
ONLY for CONTRACT

ALBERO GENEALOGICO 2008

portafotografie / family photos holder

Inglese / English

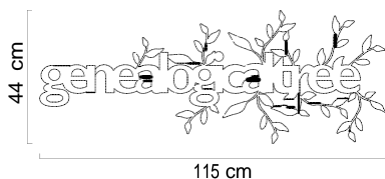

MATERIALE
acciaio lucido o verniciato,
metacrilato

Peso: Kg 2,90

COLORI
LTG-093 bianco opaco
LTG-095 acciaio lucido

MATERIAL
varnished or polished stainless steel,
acrylic

Weight: Kg 2,90

COLOURS
LTG-093 matt white
LTG-095 polished steel

Francese / French

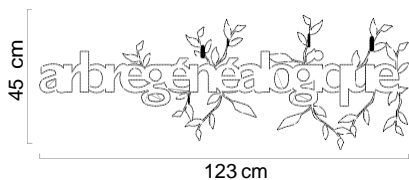

MATERIALE
acciaio lucido o verniciato,
metacrilato

Peso: Kg 2,90

COLORI
LTG-094 bianco opaco
LTG-096 acciaio lucido

MATERIAL
varnished or polished stainless steel,
acrylic

Weight: Kg 2,90

COLOURS
LTG-094 matt white
LTG-096 polished steel

BAU e MIAO 2009

portariviste, portallibri / magazine holder, books holder

Bau / Bau

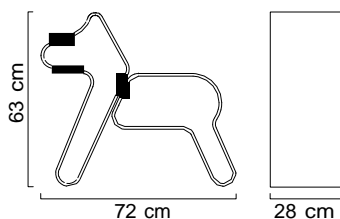

MATERIALE
metacrilato

Peso: Kg 6,00

COLORE
trasparente
con profilo giallo cangiante
LTG-130

MATERIAL
acrylic

Weight: Kg 6,00

COLOUR
transparent
with changeable yellow edge
LTG-130

Miao / Miao

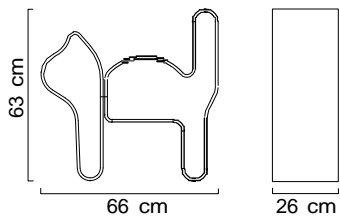

MATERIALE
metacrilato

Peso: Kg 6,00

COLORE
trasparente
con profilo violetto cangiante
LTG-131

MATERIAL
acrylic

Weight: Kg 6,00

COLOUR
transparent
with changeable violet edge
LTG-131

BOOK 2007 e 2012

libreria / bookcase

Small / Small

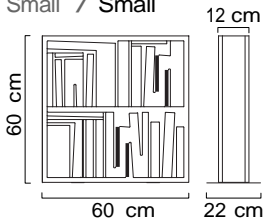

MATERIALE
metacrilato,
base in acciaio lucido

Peso: Kg 11,00

COLORI
LTG-201 rosso
LTG-202 verde
LTG-203 viola
LTG-204 bianco

Peso: Kg 19,00 Limited Edition

COLORI - Limited Edition
LTG-056 rosso
LTG-057 verde
LTG-055 viola

MATERIAL
acrylic,
polished steel base

Weight: Kg 11,00

COLOURS LTG-
201 red LTG-
202 green LTG-
203 purple
LTG-204 white

Weight: Kg 19,00 Limited Edition

COLOURS - Limited Edition
LTG-056 red
LTG-057 green
LTG-055 purple

Big / Big

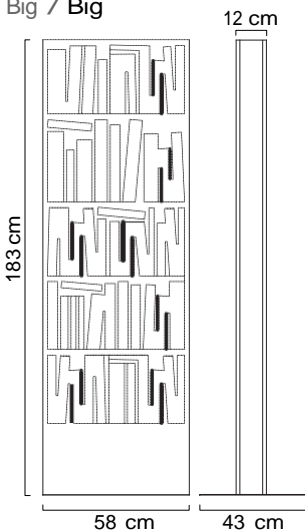

MATERIALE
metacrilato,
base in acciaio lucido

Peso: Kg 38,00

COLORI
LTG-205 rosso
LTG-206 verde
LTG-207 viola
LTG-208 bianco

Peso: Kg 89,00 - Limited Edition

COLORI - Limited Edition
LTG-087 rosso
LTG-085 verde
LTG-086 viola

MATERIAL
acrylic,
polished steel base

Weight: Kg 38,00

COLOURS LTG-
205 red LTG-
206 green LTG-
207 purple LTG-
208 white

Weight: Kg 89,00 - Limited Edition

COLOURS - Limited Edition
LTG-087 red
LTG-085 green
LTG-086 purple

Wall / Wall

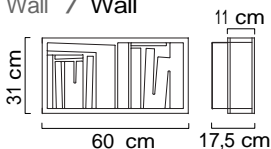

MATERIALE
metacrilato,
stafa in acciaio lucido

Peso: Kg 5,70

COLORI
LTG-225 bianco

MATERIAL
acrylic,
polished steel bracket

Weight: Kg 5,70

COLOURS
LTG-225 white

CACCIA GROSSA 2007

appendiabiti / clothes rack

Cacatua / Parrot

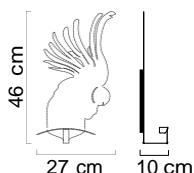

MATERIALE
acciaio,
retro in metacrilato

MATERIAL
steel,
acrylic stand

Cavallo / Horse

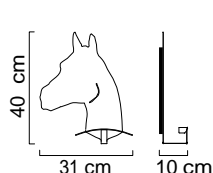

Peso Kg 1,58 Weight Kg 1,58
Kg 1,67 Kg 1,67
Kg 1,67 Kg 1,67
Kg 1,36 Kg 1,36
Kg 0,98 Kg 0,98

Peso Kg 1,58 Weight Kg 1,58
Kg 1,67 Kg 1,67
Kg 1,67 Kg 1,67
Kg 1,36 Kg 1,36
Kg 0,98 Kg 0,98

Cervo / Deer

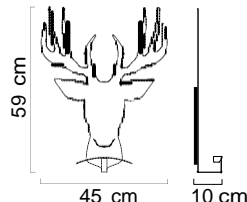

COLORI
LTG-040 Cacatua bianco opaco
LTG-028 Cavallo bianco opaco
LTG-046 Cervo bianco opaco
LTG-043 Lepre bianco opaco
LTG-107 Zebra bianco opaco

COLORI
LTG-041 Cacatua acciaio lucido
LTG-029 Cavallo acciaio lucido
LTG-047 Cervo acciaio lucido
LTG-044 Lepre acciaio lucido
LTG-091 Zebra acciaio lucido

Lepre / Hare

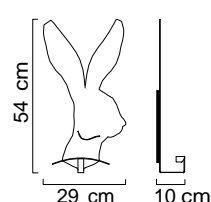

COLOURS
LTG-040 Parrot matt white
LTG-028 Horse matt white
LTG-046 Deer matt white
LTG-043 Hare matt white
LTG-107 Zebra matt white

COLOURS
LTG-041 Parrot polished steel
LTG-029 Horse polished steel
LTG-047 Deer polished steel
LTG-044 Hare polished steel
LTG-091 Zebra polished steel

Zebra / Zebra

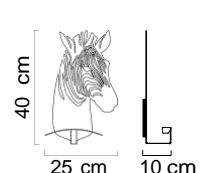

DANDY 2007 e 2012

portaombrelli / umbrella stand

Dandy / Dandy

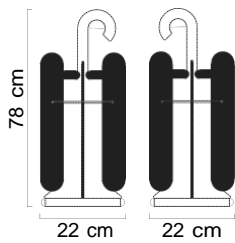

MATERIALE
metacrilato, acciaio lucido,
molla in acciaio cromato

Peso: Kg 4,10

COLORI
LTG-010 arancione
LTG-014 verde
LTG-012 azzurro

MATERIAL
acrylic, polished steel,
spring in chromed steel

Weight: Kg 4,10

COLOURS
LTG-010 orange
LTG-014 green
LTG-012 light blue

Dandy XL / Dandy XL

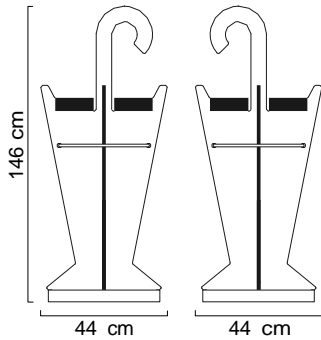

MATERIALE
metacrilato, acciaio lucido,
molla in acciaio cromato

Peso: Kg 17,00

COLORI
quantita' min. 10 pz

MATERIAL
acrylic, polished steel,
spring in chromed steel

Weight: Kg 17,00

COLOURS
min. quantity 10 pcs

ONLY for CONTRACT

TASCHE 2008

credenza da muro a 2 tasche apribili / wall sideboard with 2 folding pockets

Small / Small

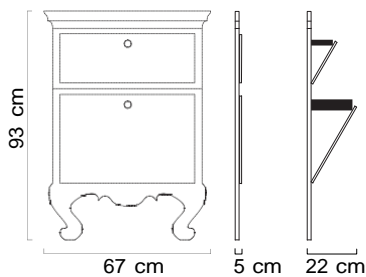

MATERIALE
legno MDF laccato lucido o opaco,
interno con tasche in tessuto,
maniglie in ottone

Peso: Kg 10,00

COLORI
LTG-103 bianco e tortora chiaro opaco
LTG-102 bordeaux lucido
LTG-101 verde lucido

MATERIAL
glossy or matt varnished MDF wood,
folding pockets in fabric
and brass handles

Weight: Kg 10,00

COLOURS
LTG-103 matt white and light dove
LTG-102 glossy bordeaux
LTG-101 glossy green

credenza da muro a 5 tasche apribili / wall sideboard with 5 folding pockets

Big / Big

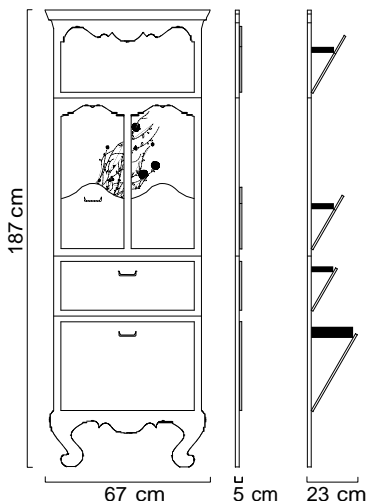

MATERIALE
legno MDF laccato opaco,
interno con tasche in tessuto,
maniglie in ottone verniciato,
5 tasche apribili,
2 specchi con serigrafia

Peso: Kg 20,00

COLORI
LTG-100 bianco e tortora chiaro opaco

MATERIAL
matt varnished MDF wood,
folding pockets in fabric
and varnished brass handles,
5 folding pockets,
2 mirrors with serigraphy

Weight: Kg 20,00

COLOURS
LTG-100 matt white and light dove

CREDENZE 2008

credenza da muro a 9 tasche apribili / wall sideboard with 9 folding pockets

Big / Big

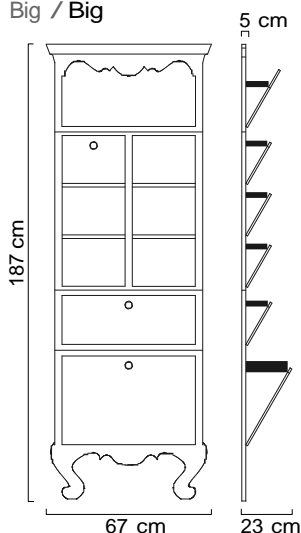

MATERIALE
legno MDF laccato lucido,
interno con tasche in tessuto,
maniglie in ottone,
9 tasche apribili

Peso: Kg 20,00

COLORI
LTG-099 bordeaux lucido
LTG-098 verde lucido

MATERIAL
glossy varnished MDF wood,
folding pockets in fabric
and brass handles,
9 folding pockets

Weight: Kg 20,00

COLOURS
LTG-099 glossy bordeaux
LTG-098 glossy green

SCRITTOIO 2012

comodino da muro / wall-mounted bedside tables

Comodini / Bedside tables

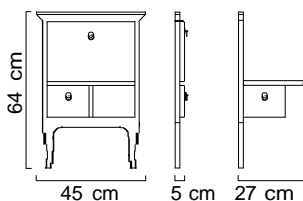

MATERIALE
legno MDF laccato,
interno rivestito di tessuto,
maniglie in ottone

Peso: Kg 5,20

COLORI
LTG-214 tortora scuro, finitura opaca
LTG-230 tortora scuro, finitura lucida

MATERIAL
lacquered MDF,
lined with fabric,
brass handles

Weight: Kg 5,20

COLOURS
LTG-214 dark dove grey, matt finish ONLY for CONTRACT
LTG-230 dark dove grey, glossy finish ONLY for CONTRACT

* Altri colori a richiesta

* Other colours on request

Scrivitoio, tavolo toilette da muro / Desk, wall-mounted toilet top

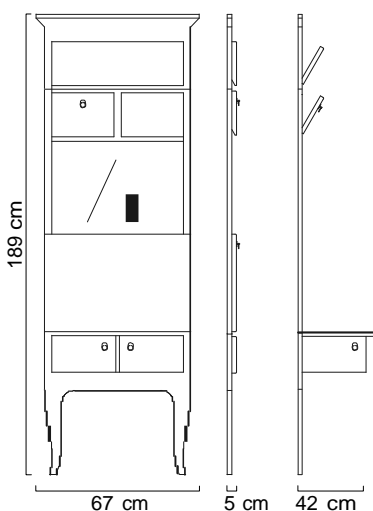

MATERIALE
legno MDF laccato,
interno rivestito di tessuto,
maniglie in ottone

Peso: Kg 19,00

COLORI
LTG-212 tortora scuro, finitura opaca
LTG-228 tortora scuro, finitura lucida

MATERIAL
lacquered MDF,
lined with fabric,
brass handles

Weight: Kg 19,00

COLOURS
LTG-212 dark dove grey, matt finish ONLY for CONTRACT
LTG-228 dark dove grey, glossy finish ONLY for CONTRACT

* Altri colori a richiesta

* Other colours on request

Sgabello, sedia / Stool, smart chair

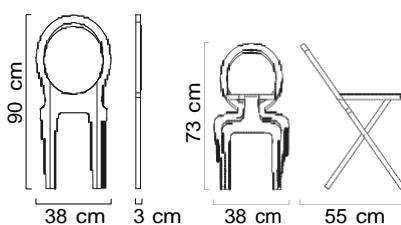

MATERIALE
legno MDF laccato,
seduta rivestita di tessuto,
maniglie in ottone

Peso: Kg 4,30

COLORI
LTG-213 tortora scuro, finitura opaca
LTG-229 tortora scuro, finitura lucida

MATERIAL
lacquered MDF,
seat covered with fabric,
brass handles

Weight: Kg 4,30

COLOURS
LTG-228 dark dove grey, matt finish ONLY for CONTRACT
LTG-228 dark dove grey, glossy finish ONLY for CONTRACT

* Altri colori a richiesta

* Other colours on request

ITALIAN 50's 2012

sedia / chair

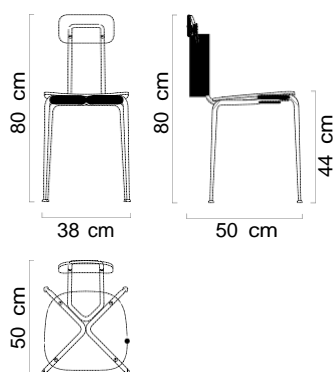

MATERIALE
struttura in metallo
seduta e spalliera in metacrilato

Peso: Kg 5,00

MATERIAL
metal structure
seat and back in acrylic

Weight: Kg 5,00

COLORE
cromo,
trasparente con profilo
verde chiaro cangiante
LTG-218

COLOUR
shiny metal,
transparent with changeable
light green edge
LTG-218

MERLOT 2012

tavolino, comodino, coffee table / side tables, coffee tables

piccolo e alto /small & tall basso e largo /short & large

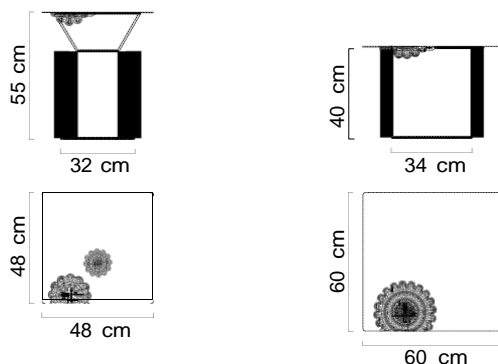

MATERIALE
metallo verniciato
Peso: Kg 6,20

MATERIAL
varnished metal
Weight: Kg 6,20

COLORE
LTG-215 bianco opaco
piccolo e alto, due pizzi

COLOUR
LTG-215 matt white
small and tall, two laces

MATERIALE
metallo verniciato
Peso: Kg 8,50

MATERIAL
varnished metal
Weight: Kg 8,50

COLORE
LTG-216 bianco opaco
basso e largo, un pizzo

COLOUR
LTG-216 matt white
short and large, one lace

Moodern 2012

sedia / chair

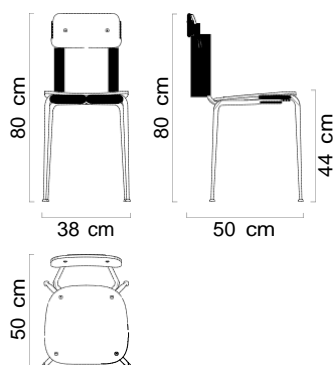

MATERIALE
struttura in metallo verniciato
seduta e spalliera in metacrilato bi-sabbiato
Peso: Kg 5,00

MATERIAL
varnished metal structure
seat and back in dual-frosted acrylic
Weight: Kg 5,00

COLORE
LTG-217 bianco
LTG-234 giallo becco d'oca
LTG-235 rosso bordeaux
LTG-236 blu carta da zucchero

COLOUR
LTG-217 white
LTG-234 yellow
LTG-235 burgundy
LTG-236 antique blue

PAPIER 2010

cestino per la carta / waste paper basket

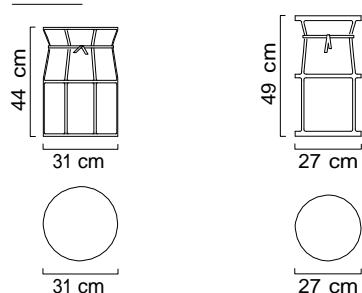

MATERIALE
acciaio
Peso: da Kg 0,40 a Kg 0,90

MATERIAL
steel
Weight: from Kg 0,40 to Kg 0,90

COLORE
LTG-177 basso e largo _acciaio lucido
LTG-178 piccolo e alto, _acciaio lucido

COLOUR
LTG-177 short and large _polished steel
LTG-178 small and tall _polished steel

* Dimensioni:
in base agli sfridi di produzione

* Dimensions:
depending on wasting materials availability

CELEBRI SCENE 2012

comodini / bedside tables

Romeo & Giulietta / Romeo & Juliet

Aspettando Godot / Waiting for Godot

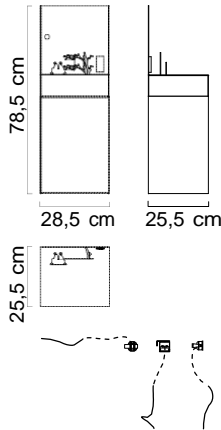
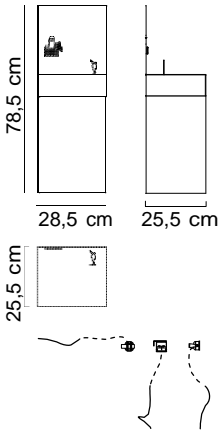

MATERIALE
metallo verniciato
Peso: Kg 11,00

COLORE
LTG-210 R&G bianco e nero opaco
LTG-211 AG bianco e nero opaco

LTG-232 faretto nero
riposizionabile, con calamita
Luce LED
220-240Volts
2,3Watt
+ gelatine colorate
blu, arancione, bianco, viola
Peso: Kg 0,25
(opzionale)

MATERIAL
varnished metal
Weight: Kg 11,00

COLOURS
LTG-210 R&G matt white and black
LTG-211 AG matt white and black

LTG-232 black light,
repositionable, with magnet
LED light
220-240Volts
2,3Watt
+ color filters
blue, orange, white, purple
Weight: Kg 0,25
(optional)

LONDRA, 1666 e ROMA, DCCCXVII a.U.c 2009

parascintille / spark arrester

Londra / London

Roma / Rome

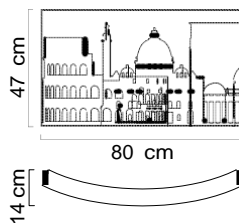
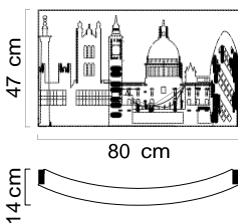

MATERIALE
acciaio
cor-ten
Peso: Kg 6,42
Peso: Kg 7,05

COLORE
LTG-126
Londra, ematite
LTG-125
Roma, rosso brunito

MATERIAL
steel
cor-ten
Weight: Kg 6,42
Weight: Kg 7,05

COLOURS
LTG-126
London, black hematite
LTG-125
Rome, rust red

SDRAIAMI design 2008

portariviste / magazines holder

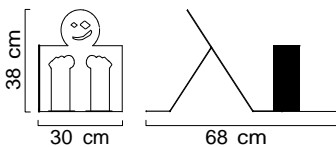

MATERIALE
steel
Peso: Kg 3,65

COLORE
LTG-082 acciaio lucido

MATERIAL
steel
Weight: Kg 3,65

COLOUR
LTG-082 polished steel

SKETCH MINI 2010

Sketch mini chair / Sketch mini chair

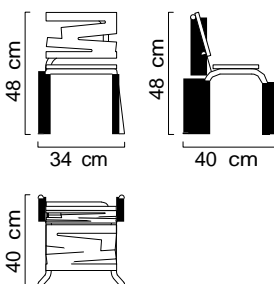

MATERIALE
struttura in metallo verniciato
seduta e spalliera in metacrilato
Peso: Kg 3,80

COLORE
LTG-151
metallo verniciato grigio,
metacrilato bianco, rosso, verde e viola
(secondo disponibilita')

MATERIAL
varnished metal structure
seat and back in acrylic
Weight: Kg 3,80

COLOUR
LTG-151
grey varnished metal
white, red, green and purple acrylic
(according to availability)

Sketch mini bench A / Sketch mini bench A

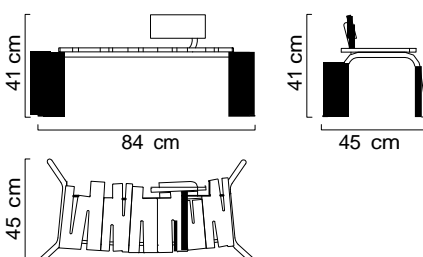

MATERIALE
struttura in metallo verniciato
seduta e spalliera in metacrilato
Peso: Kg 6,10

COLORE
LTG-153 panchetta curva
metallo verniciato grigio,
metacrilato bianco, rosso, verde e viola
(secondo disponibilita')

MATERIAL
varnished metal structure
seat and back in acrylic
Weight: Kg 6,10

COLOUR
LTG-153 curve mini bench
grey varnished metal
white, red, green and purple acrylic
(according to availability)

SKETCH MINI 2010

Sketch mini bench B / Sketch mini bench B

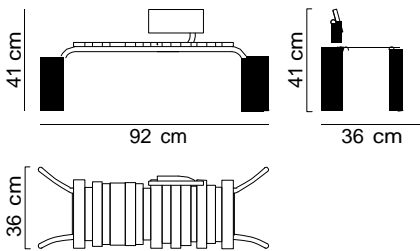

MATERIALE
struttura in metallo verniciato
seduta e spalliera in metacrilato

Peso: Kg 6,30

MATERIAL
varnished metal structure
seat and back in acrylic

Weight: Kg 6,30

COLORE
LTG-155 panchetta dritta
metallo verniciato grigio,
metacrilato bianco, rosso, verde e viola
(secondo disponibilita')

COLOUR
LTG-155 straight mini bench
grey varnished metal
white, red, green and purple acrylic
(according to availability)

Sketch mini desk / Sketch mini desk

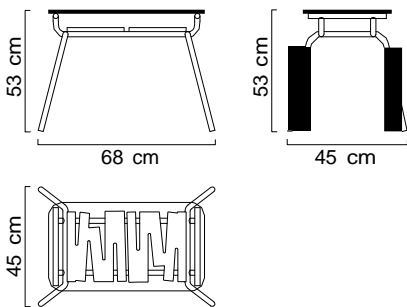

MATERIALE
struttura in metallo verniciato
seduta e spalliera in metacrilato

Peso: Kg 7,80

MATERIAL
varnished metal structure
seat and back in acrylic

Weight: Kg 7,80

COLORE
LTG-152
metallo verniciato grigio,
metacrilato bianco, rosso, verde e viola
(secondo disponibilita')

COLOUR
LTG-152
grey varnished metal
white, red, green and purple acrylic
(according to availability)

COFFE' TABLE 2009

tavolino con vassoio / coffee table with tray

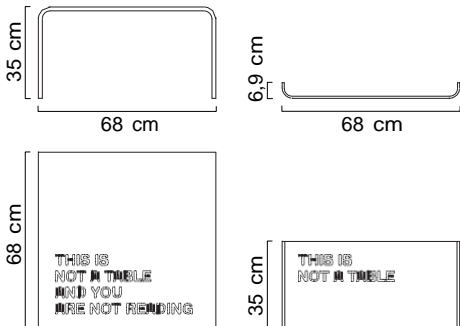

MATERIALE
metacrilato

Peso: Kg 18,00

MATERIAL
acrylic

Weight: Kg 18,00

COLORE
LTG-138 bianco opal

COLOUR
LTG-138 opalescent white

comodini "PER LUI...PER LEI" / "for him" and "for her" bedside tables

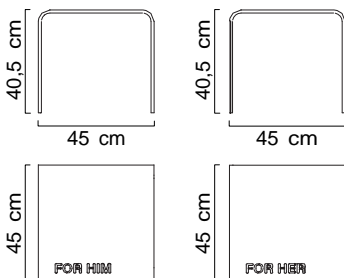

MATERIALE
metacrilato

Peso: Kg 7,80

MATERIAL
acrylic

Weight: Kg 7,80

COLORE
trasparente
con profilo giallo cangiante
LTG-136 "for him"
LTG-137 "for her"

COLOUR
transparent
with changeable yellow edge
LTG-136 "for him"
LTG-137 "for her"

mensola alambiccio / alembic shelf

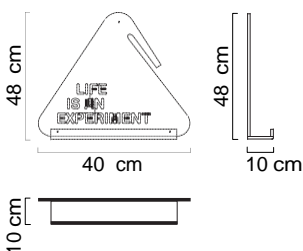

MATERIALE
metacrilato

Peso: Kg 2,60

MATERIAL
acrylic

Weight: Kg 2,60

COLORE
LTG-140 trasparente turchese

COLOUR
LTG-140 transparent turquoise

VOX MOBILI 2009

mensola fumetto / comics shelf

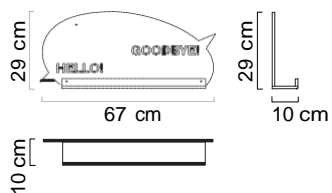

MATERIALE
metacrilato
Peso: Kg 2,60

MATERIAL
acrylic
Weight: Kg 2,60

COLORE
LTG-141 trasparente rosso

COLOUR
LTG-141 transparent red

mensola nuvola / cloud shelf

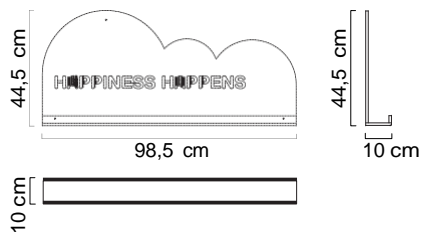

MATERIALE
metacrilato
Peso: Kg 5,20

MATERIAL
acrylic
Weight: Kg 5,20

COLORE
LTG-139 trasparente arancione

COLOUR
LTG-139 transparent orange

101 STORIE D'AMORE 2011

tagliere, vassoio / cutting board, tray

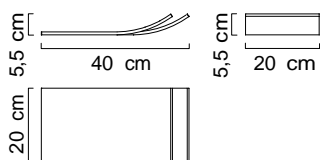
MATERIALE
solid surface

Peso: Kg 1,20

COLORE
LTG-188 biancoMATERIAL
solid surface

Weight: Kg 1,20

COLOUR
LTG-188 white

LANTERNA FARFALLA 2009

lanterna / lantern

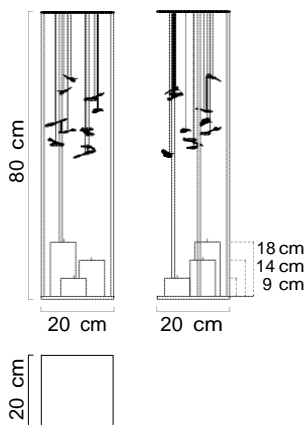
MATERIALE
ottone

Peso: Kg 4,50

COLORE
LTG-134 oro satinatoMATERIAL
brass

Weight: Kg 4,50

COLOUR
LTG-134 brushed gold

CINQUE WATT 2011

luce-libro / table lamp

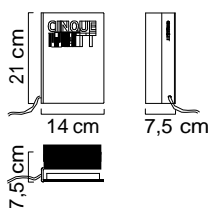
MATERIALE
metacrilato, alluminio, luce led.

Peso: Kg 0,67

COLORE
LTG-191 alluminio e biancoLUCE LED
220-240Volts
9WattMATERIAL
acrylic, aluminium, led light.

Weight: Kg 0,67

COLOUR
LTG-191 aluminium and whiteLED LIGHT
220-240Volts
9Watt

CÙ CÙ 2008

orologio da tavolo / table clock

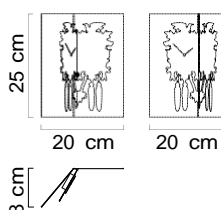
MATERIALE
acciaio

Peso: Kg 0,85

COLORE
LTG-092 acciaio lucidoMATERIAL
stainless steel

Weight: Kg 0,85

COLOUR
LTG-092 polished steel

GIORNI DA LEONE 2009

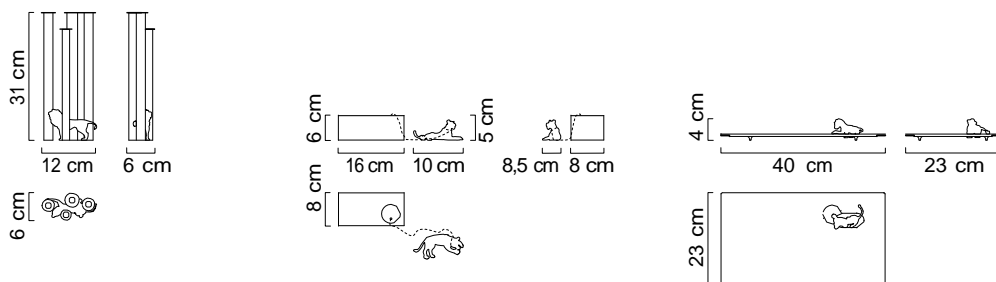
candelabro, portafiori /
bud vase, candlestickportagioie /
jewelry casevassoio /
trayMATERIALE
metacrilato, metalloMATERIAL
acrylic, metalPeso
Kg 1,20
Kg 0,90
Kg 1,04Weight
Kg 1,20
Kg 0,90
Kg 1,04COLORI
LTG-200 candelabro bianco, oro rosa
LTG-199 portagioie bianco, oro rosa
LTG-198 vassoio bianco, oro rosaCOLOURS
LTG-200 candlestick white, pink gold
LTG-199 jewelry case white, pink gold
LTG-198 tray white, pink gold

LUMIÈRE 2008

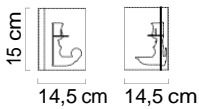
candelabro_bugia /
candlestick_bugia

MATERIALE
acciaio
MATERIAL
stainless steel

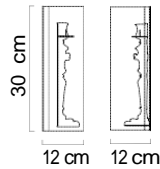
candelabro_mono-braccio /
one-armed candlestick

Peso Weight
Kg 0,33 Kg 0,33
Kg 0,52 Kg 0,52
Kg 1,00 Kg 1,00
Kg 1,00 Kg 1,00

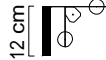
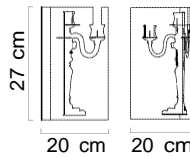
candelabro_a tre braccia /
three-armed candelabrum

COLORI
LTG-183 acciaio lucido
LTG-184 acciaio lucido
LTG-135 acciaio lucido
LTG-209 bianco opaco

COLOURS
LTG-183 polished steel
LTG-184 polished steel
LTG-135 polished steel
LTG-209 matt white

MERLOT 2009 e 2011

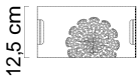
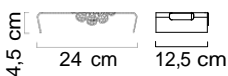
piccolo vassoio /
small tray

MATERIALE
acciaio
MATERIAL
stainless steel

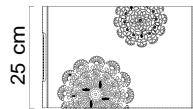
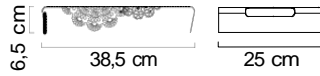
vassoio /
tray

Peso Weight
Kg 0,40 Kg 0,40
Kg 1,75 Kg 1,75
Kg 0,40 Kg 0,40
Kg 1,75 Kg 1,75
Kg 1,72 Kg 1,72

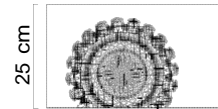
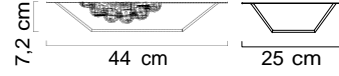
alzata /
riser, centerpiece

COLORI
LTG-182 piccolo vassoio oro lucido
LTG-180 vassoio oro lucido

COLOURS
LTG-182 small tray burnished gold
LTG-180 tray burnished gold

LTG-150 piccolo vassoio acciaio lucido
LTG-121 vassoio acciaio lucido
LTG-120 alzata acciaio lucido

LTG-150 small tray polished steel
LTG-121 tray polished steel
LTG-120 riser polished steel

OROLO-OGIO 2008

orologio da muro / wall clock

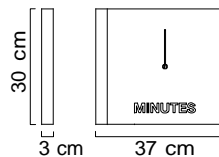
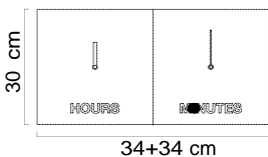

MATERIALE
cartone vegetale teso

Peso: Kg 0,41

COLORE
LTG-089 antracite

MATERIAL
taut plant cardboard

Weight: Kg 0,41

COLOUR
LTG-089 anthracite

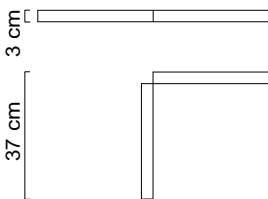

PORTABLE DRAMA_2009

luce d'ambiente / atmosphere light

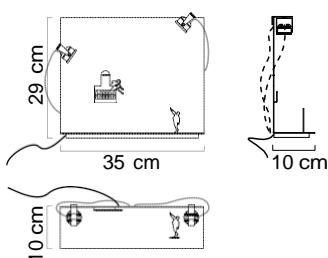

MATERIALE
acciaio
luce led

Peso: Kg 3,45

COLORE
LTG-132 bianco opaco

Luce LED
220-240Volts
2,3Watt x 2
+ gelatine colorate
blu, arancione, bianco, viola

MATERIAL
steel
led light

Weight: Kg 3,45

COLOUR
LTG-132 matt white

Luce LED
220-240Volts
2,3Watt x 2
+ color filters
blue, orange, white, purple

POSATE! 2011

sottopentola / trivet

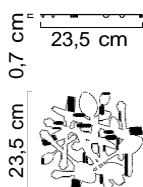
MATERIALE
acciaio

Peso: Kg 0,35

COLORE
LTG-192 acciaio lucidoMATERIAL
stainless steel

Weight: Kg 0,35

COLOUR
LTG-192 polished steel**POSSO MA NON VOGLIO** 2008

portacioccolatini / display chocolates & case

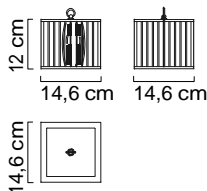
MATERIALE
ottone dorato

Peso: Kg 1,70

COLORE
LTG-070 oro lucidoMATERIAL
golden plated brass

Weight: Kg 1,70

COLOUR
LTG-070 burnished gold**SFOGO** 2011

vassoio in legno, tagliere, antistress / cutting board, tray, antistress

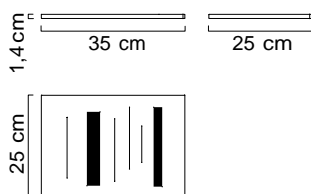
MATERIALE
legno preinciso

Peso: Kg 0,75

COLORE
LTG-189 legno con bordo biancoMATERIAL
pre-engraved wood

Weight: Kg 0,75

COLOUR
LTG-189 wood with white edge